

SME

The best pick-up arm in the world



INSTRUCTIONS

SERIES V
MAGNESIUM TONE-ARM

Introduction

In developing the Series V precision pick-up arm with unique one-piece magnesium tone-arm we aimed to establish a new reference standard by applying, without price constraint, experience in mechanical and electrical engineering gained over more than a quarter of a century.

In theoretical terms an ideal pick-up arm is supposed to be perfectly unyielding in four out of six possible degrees of freedom. That is, all except the two linear dimensions in which the music signal is generated by groove modulation. In those two linear dimensions an ideal arm is supposed to act as a pure mass.

The Series V now brings this concept closer to reality. It has been described as a significant contribution to the art of replaying vinyl discs. We believe its user will find it not only a source of lasting pleasure but that we have succeeded in our task to create anew,

The best pick-up arm in the world

This instruction manual has received the same attention to detail in its preparation as the Series V precision pick-up arm. Please read it carefully before attempting installation and use. Time spent in this way will be well rewarded.

Contents

Page	
2	Introduction
4	General arrangement
5	Dimensions and specification
6	Packing list
7	Parts identification
8 - 9	Preparing the pick-up mounting board
10-11	Cartridge fitting
11	Cartridge lead replacement
11-12	Fitting the arm
12	Audio lead
13	Cartridge fitting, arm mounted on deck
13	Longitudinal balance
14	Vertical tracking force (VTF) adjustment
14-15	Arm height (VTA) adjustment
16-17	Horizontal tracking angle (HTA) adjustment
17	Positioning the armrest
17	Locking the base
18	Anti-skate control
18-19	Operation
19	Adjusting height of lift
20	Filling the damper reservoir
21	Operating the damper
22	Cleaning the damper reservoir
22	Cleaning the arm lift
23	Appendix

General arrangement

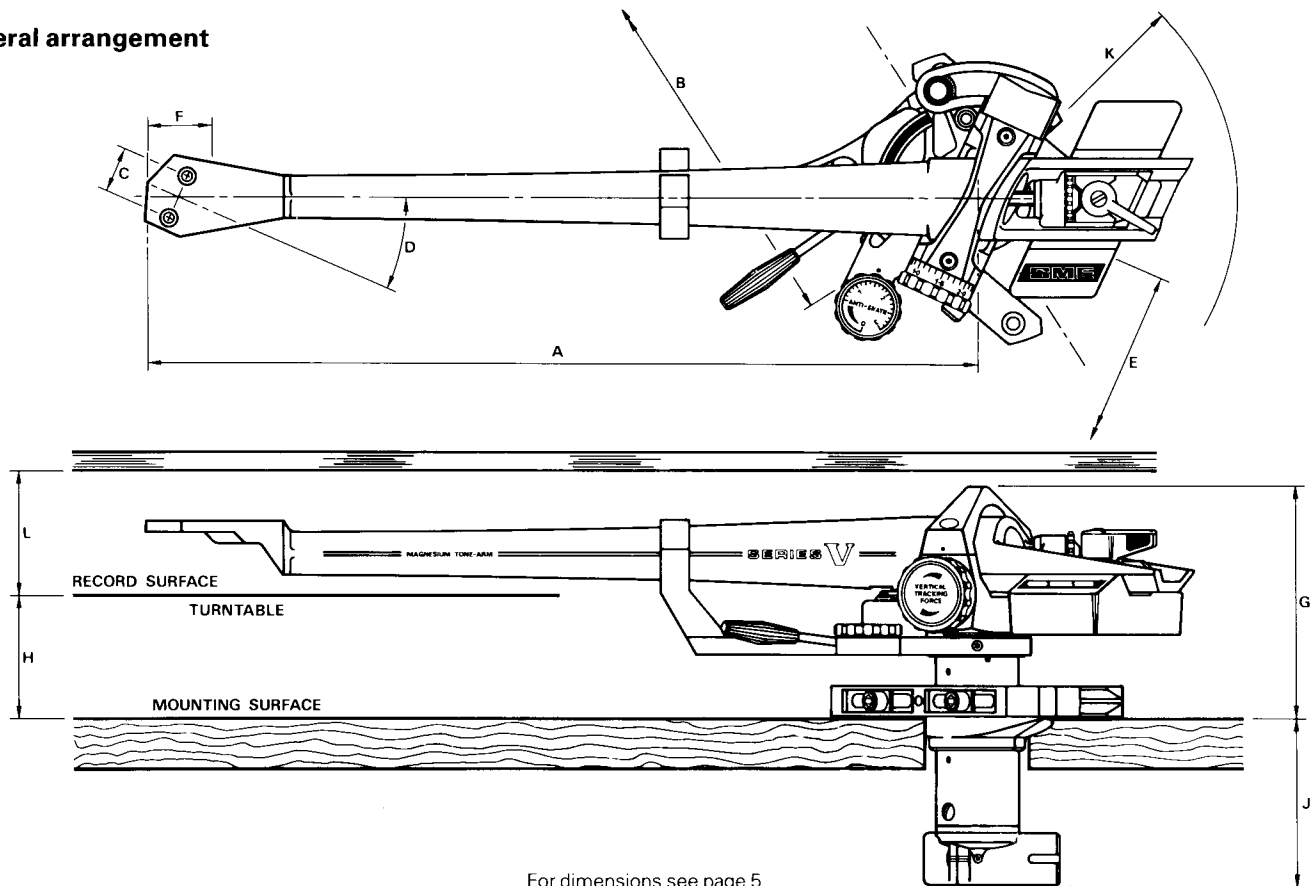

Dimensions

	mm
A – Distance from pivot to stylus	233,15
B – Distance from pivot to turntable centre	215,35
C – Cartridge fixing centres	12,7
D – Offset angle	23.635 deg
E – Linear offset	93,47
F – Overhang	17,8
G – Height above mounting surface	{ max 87,9 min 56,4
H – Height of record surface above mounting surface	{ max 57,9 min 26,4
J – Depth below mounting surface	56,75
K – Radial clearance for balance weight	73,0
L – Clearance between cabinet lid and record surface assuming cartridge height at 17,0 mm	35,0

Specification

Effective mass	10/11 g
Cartridge balance range	up to 14.0 g
Vertical tracking force	0-3.0 g (30 mN)
Maximum tracking error	0.012 deg/mm
Null points:	
Inner	66,04 mm
Outer	120,9 mm
Audio lead:	
Length	1,2m
Capacitance	\cong 140 pF per channel
Resistance	\cong 0.145 ohms per conductor
Internal wiring:	
Capacitance	\cong 15 pF per channel
Resistance	\cong 0.535 ohms per conductor
Output plug and socket	D.I.N. 5-pole 240°
Weight, net	720.0 g

Packing list

The pack is the only one in which your Series V precision pick-up arm can be safely transported. Please keep it for possible future use. It contains the following: —

Series V precision pick-up arm

Instruction book

Mounting jig With M5 screw, nut and thumbwheel

Alignment protractor

Mounting template

Record spindle bush

Shell hardware Finger lift and 2 washers
Set of 6 stainless steel cap screws, 2 nuts and 2 washers
Set of 8 aluminium alloy screws and 2 nuts
2,0 A/F hexagon wrench
5,0 A/F spanner
~~Spare set of cartridge connecting leads~~

3,0 A/F ball-ended hexagon
wrench with handle

Mounting hardware Set of 4 socket cap screws, 4 nuts and 4 washers
2,5 A/F hexagon wrench

Audio lead

VTA screw

HTA key

0,89 A/F hexagon wrench

Damping fluid in syringe

1/16" A/F hexagon wrench

Guarantee card

Sachet of silica gel

Parts identification

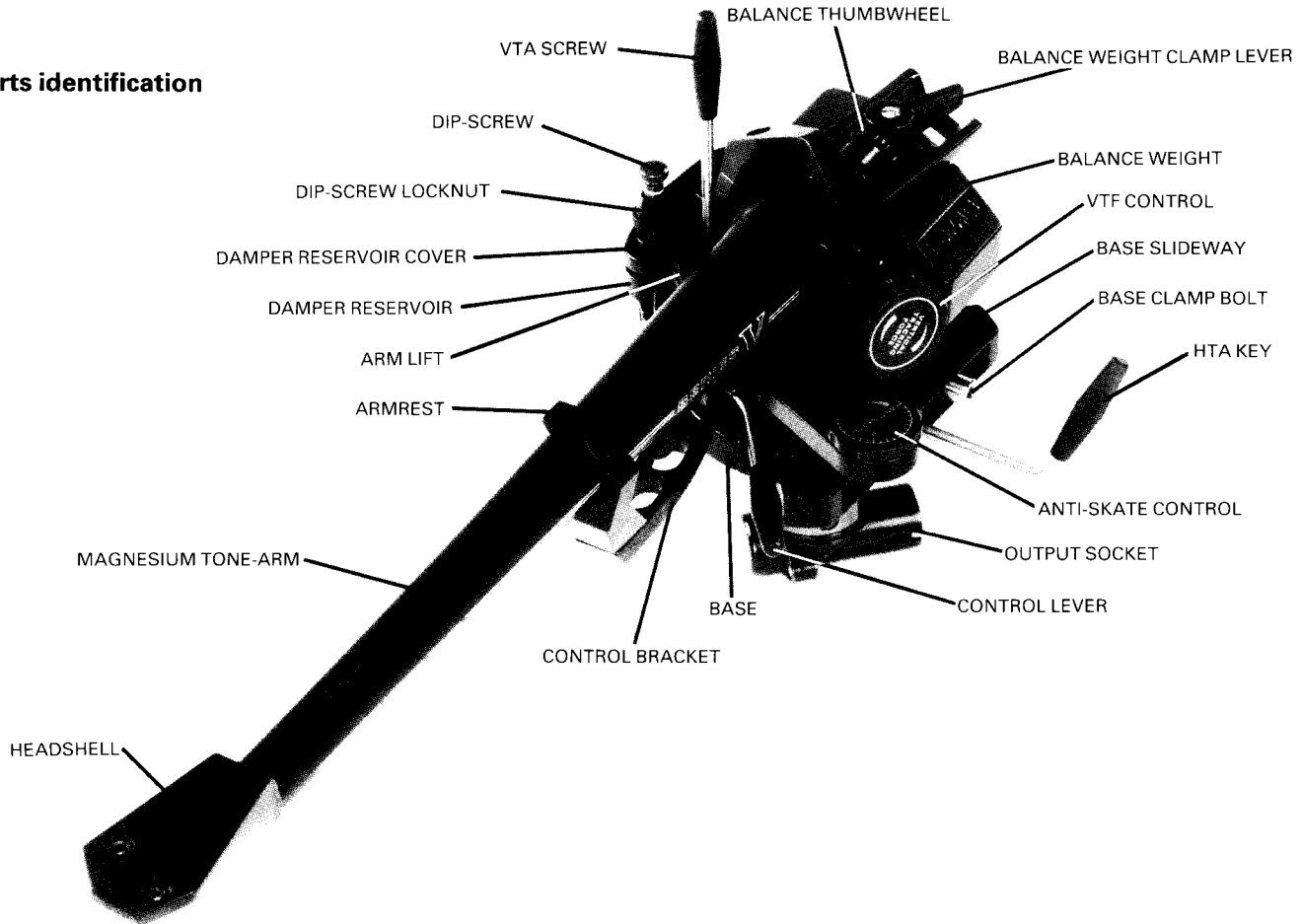

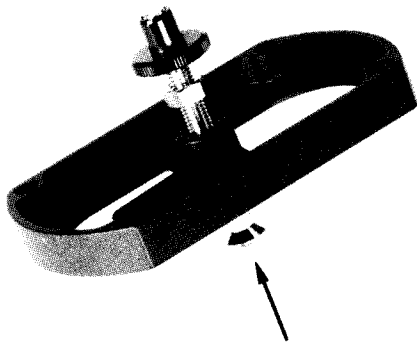

501 Preparing the pick-up mounting board

Assemble the M5 screw in the mounting jig. Secure with the nut, holding the screw with a coin and fit the thumbwheel, boss uppermost.

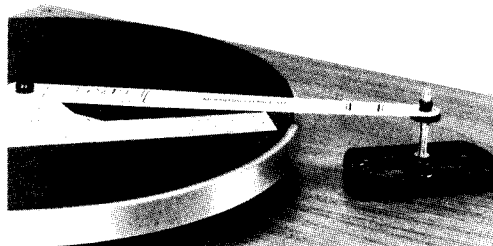

502

Place the record spindle bush in position with the alignment protractor over it followed by the mounting template. The opposite end of the template must engage the boss of the thumbwheel, which is then adjusted to bring it level with the turntable.

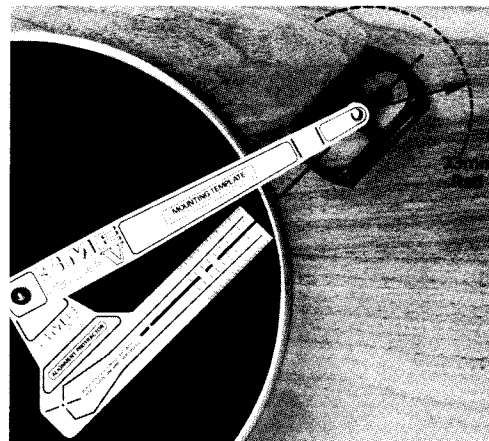

503

The jig represents the arm base and is shown with its centreline on that of the alignment protractor. This gives the maximum effective range of HTA adjustment, Figure 525. It can be rotated anti-clockwise up to a point where its right-hand edge is parallel with that of the deck. This will, however, increasingly reduce the effective range of adjustment but is unimportant provided that the requirements of the alignment protractor can still be satisfied, Figures 526/7/8. Find the best position relative to the turntable, noting the 73 mm radial clearance required behind the vertical pivot for the balance system.

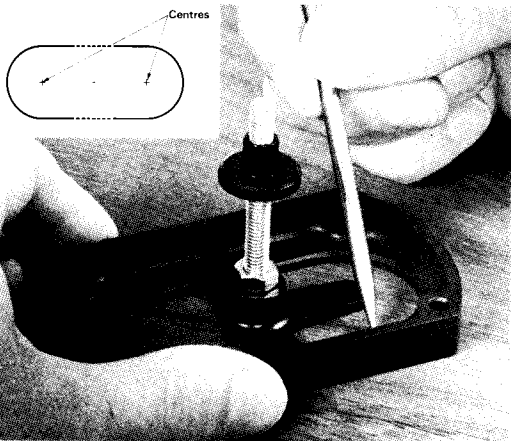

504 Preparing the pick-up mounting board (continued)

Remove the mounting template and alignment protractor, maintaining the position of the jig. Mark around its internal outline with a scribe or sharp pencil. Spike centre through the hole in the projecting lug. Reverse the jig and repeat.

Scribe two parallel lines to join the D-shaped areas in the form of a slot.

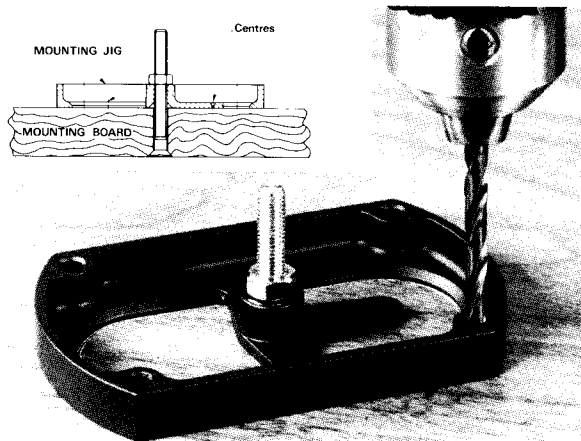

505

Extreme accuracy in initial jig positioning is not needed due to the adjustments inbuilt in the arm. However, the relationship of the four fixing holes to one another is important so the jig must not be allowed to wander during drilling. We recommend that the M5 screw be used to secure the jig to the motorboard. A 6 mm (1/4") diameter hole should be drilled mid-way between the points already centred, the screw being passed through the board and jig and secured with the nut. Ensure that it coincides with the lines already marked out and tighten up. The four 4 mm (5/32") diameter holes can now be drilled as shown.



506

Remove the jig so that the marked area can be cut out. Drill two holes 28 mm (1 1/8") diameter. Cut away the remaining area to complete the slot and finish the edges with a file and glasspaper. If a hole saw is not available drill a series of small holes around the inside of the line, saw out and file.

Given suitable tools the procedure is similar for materials other than wood.

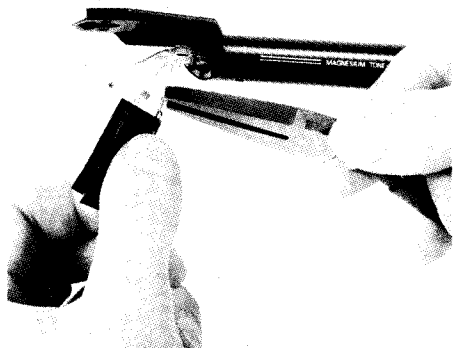

507 Cartridge fitting

If this is done before fitting the arm to the turntable, a stylus guard should be used and is particularly important until there is full familiarity in handling, Figure 516.

The silver-litz cartridge leads have 1 mm diameter receptacles for the arm and standard 1,25 mm for the cartridge. The latter may require adjustment with pliers or a screwdriver blade for a snug fit on non-standard terminals.

Connections must never be made by direct soldering.

The coding is:—

- Red – right channel signal
- Green – right channel ground
- White – left channel signal
- Blue/Black – left channel ground

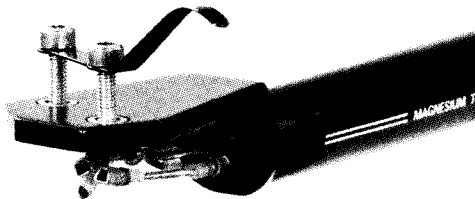

508

Three lengths of stainless steel socket cap screws, nuts and washers are provided for cartridge fixing:—

- 8,0 mm ($\frac{5}{16}$ ")
- 12,0 mm ($\frac{1}{2}$ ")
- 16,0 mm ($\frac{5}{8}$ ")

Select a pair, using the shorter if more than one length is suitable. For the purist, use without the finger lift is preferred but it is unlikely that the difference will be audible. When used, the two stainless steel washers should first be fitted to the counterbores in the headshell.

The stainless steel washers, two in each counterbore, are also required to protect the enamel finish when the cartridge fixing screws are used with the nuts on top of the shell.

For high compliance cartridges the aluminium alloy screws and nuts offer some reduction in the arm's effective mass. Make a careful choice of screwdriver to avoid marring the heads.

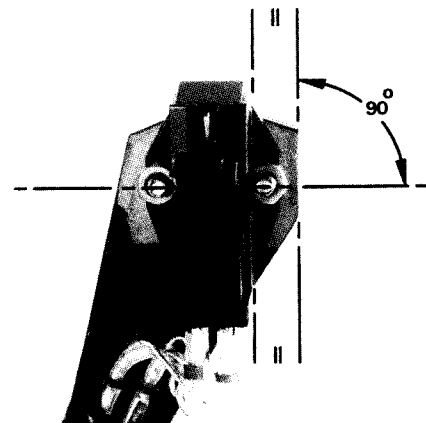

509

Examine the top of the cartridge. It is important that it presents a good flat face to the underside of the headshell. Before final tightening check that the cartridge is lying parallel to the reference edge of the headshell as shown.

The majority of cartridges present a body height in excess of 16 mm. With cartridges below 16 mm, a 3,2 mm ($\frac{1}{8}$ ") aluminium spacer will be needed between the cartridge and shell for correct clearance between the tone-arm and record edge, Figures 523-524. Part number P925 is available from us.

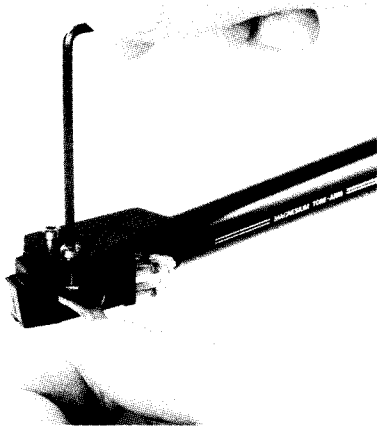

510 Cartridge fitting (continued)

Tighten the cartridge fixing screws securely using the 2,0 A/F hexagon wrench and spanner. The cap screws are non-magnetic. Damage can be caused if a screw is snatched by magnetic attraction whilst being offered up to the cartridge. For the same reason do not lay tools down nearby.

WARNING

Socket cap screws make high compression forces possible. Avoid over-tightening with cartridges having non-metallic mounting surfaces.

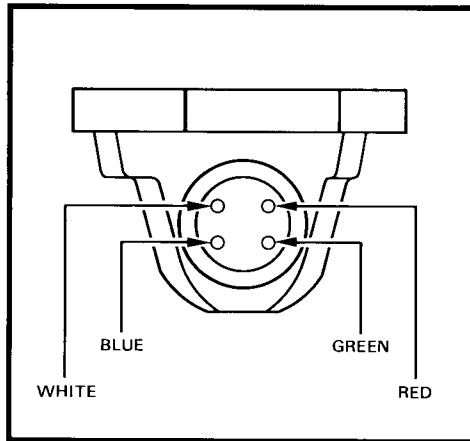

511 Cartridge lead replacement

The internal wiring terminates in a four-pin plug at the back of the headshell. The silver-litz cartridge leads, Part No. P899, can therefore be replaced and may be obtained from your dealer or direct from us.

They should be fitted with due regard to their colour coding as shown above, see also Figure 507.

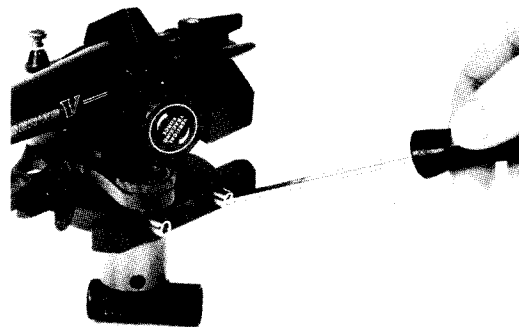

512 Fitting the arm

The base can be rotated on the pillar so that the clamp bolts are presented on the side giving the best access. Using the 3,0 A/F hexagon wrench, see that both are lightly locked and then release three-quarters of a turn only. This will enable the base to be moved on the pillar, and also the base slide-ways to be moved in relation to the base. The clamp bolts must not be relocked until installation and adjustments have been completed. The movements are internally spring loaded so settings will not be lost in the meantime.

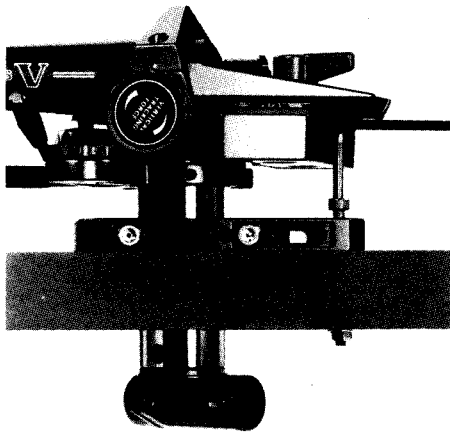

513 Fitting the arm (continued)

Move the two base slideways fully backwards in relation to the base. Position the arm on the pick-up mounting board and insert two of the M3 socket cap screws into the rear mounting holes. Fit the nuts and washers under the board so that the screws are pulled home but do not fully tighten. The screws are 22 mm long and suit the majority of applications.

For an exceptionally thick mounting board they should be replaced with M3 × 35 mm socket cap screws, Part No. P893/35, available direct from us in the event of difficulty.

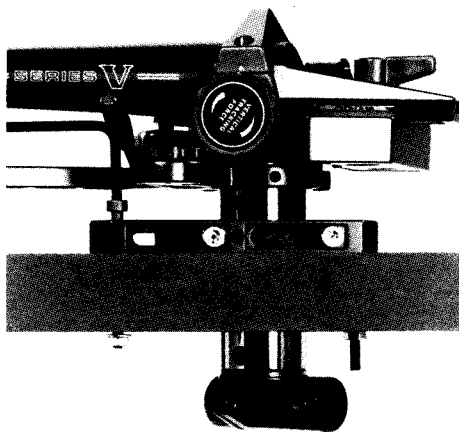

514

Move the arm into the fully rearward position, either manually or using the HTA key, Figure 525. Insert the two remaining screws and fit the nuts and washers. The four screws should now be firmly and evenly tightened using the 2,5 A/F hexagon wrench. Excessive tightness should be avoided. Care should be taken that the fine finish of the arm is not marred by the wrench coming into contact with it. It may be more convenient to use this reversed, with the long leg engaging the screw.

The arm height has been set at the factory to suit the pack. At this point the setting may be altered manually or by reference to Figure 520.

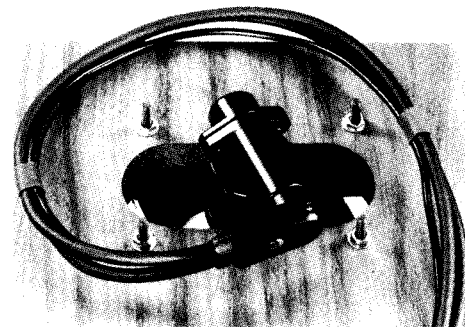

515 Audio lead

Insert the output plug. The socket rotates through 315 degrees allowing it to take up the best position. When using a floating deck a generous loop should be formed in the lead to minimise mechanical coupling. A single connection only must exist between the ground terminal of the deck and pre-amp. This must be omitted, however, where an electrical path already exists due to a metal mounting board for example. In this case the ground wire of the audio lead will serve the deck as well as the arm. In all cases this wire must be connected to the ground terminal of the pre-amp. The flying leads from the back of the phono plugs must also be grounded to the piece of equipment to which the plugs are connected, i.e. transformer, head amp or pre-amp.

The system has been designed for high S/N and if this is not achieved suspect the existence of additional ground paths. For example, a direct ground connection between the deck and the mains.

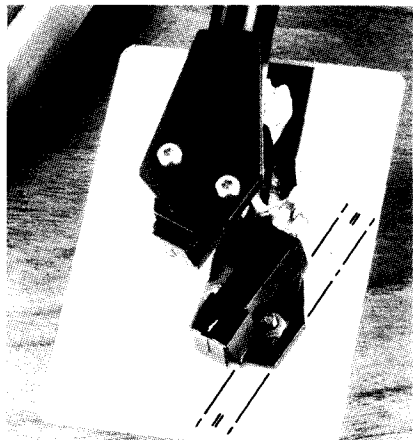

516 Cartridge fitting – arm mounted on deck

If it should be necessary to fit a cartridge to the arm after it has been mounted on the deck, first refer back to Figures 507/8/9. View the cartridge in a mirror laid beneath it. Use an electric torch or other convenient light source to highlight the reference edges of the headshell and cartridge which must be adjusted until parallel. Finally, tighten the screws checking that the correct position has been maintained, Figure 510.

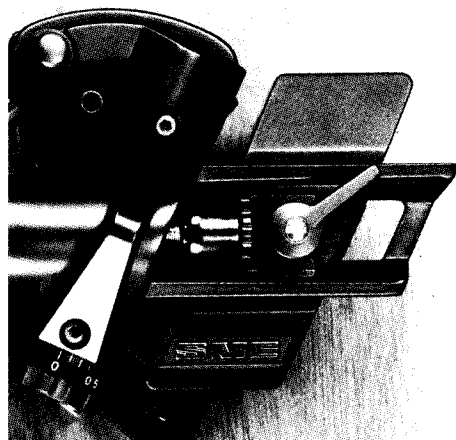

517 Longitudinal balance

If a detachable stylus guard is used it should now be removed, thereafter handling the arm with suitable caution. The balance weight clamp lever is unlocked by moving it anti-clockwise.

When required the action of the clamp lever can be adjusted as follows:—

Remove the central screw and lift the clamp lever upwards from its boss, using a slight rocking movement. Replace the lever in a new position one spline at a time, anti-clockwise to increase locking pressure and clockwise to reduce it. Replace the central screw.



518

Check that both the vertical tracking force (VTF) and anti-skate controls are set to zero. Position the arm so that the cartridge is clear of the turntable and the arm is clear of the arm-rest. Balance is achieved by rotating the thumbwheel carried on the leadscrew which moves the balance weight. Adjust until the arm with cartridge fitted is either level or slightly low at the front when the clamp lever is relocked.



519 Vertical tracking force (VTF) adjustment

For safety the lever of the lowering control should be in the raised position before VTF is applied. The scale covers a full range of 3 grams (30 mN). It is divided into units of half a gram (5 mN) and subdivided in eighths of a gram (1,25 mN). To apply VTF move the control anti-clockwise until the required position coincides with the index point. The illustration shows 1,5 grams (15 mN).



520 Arm height (VTA) adjustment

Insert the VTA screw into its socket as shown. Rotate clockwise until resistance is felt. Further rotation will increase the height of the tone-arm relative to the base.



521

To lower the tone-arm turn the VTA screw anti-clockwise. Finger pressure will then move the arm downwards until it stops on the screw, at which point further movement in either direction can be made as needed.

Take care not to bend the VTA screw either by accidentally knocking it or, if the arm is mounted in a plinth, closing the lid on it.

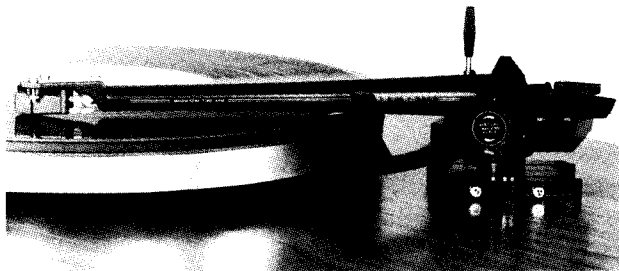

522 Arm height (VTA) adjustment (continued)

As the possibility of accidental damage cannot be ruled out, the use of an old record for the following procedures is recommended.

Place the arm about halfway across the record and move the control lever forward to lower it into the playing position. Adjust the arm height, Figure 520-21, until there is approximately 3 mm ($1/8$ ") clearance between the underside of the tone-arm and the surface of the record at its circumference.

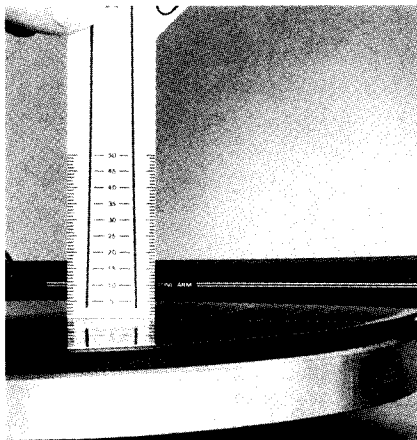

523

In standard operation the mounting surface of the cartridge, underside of the shell and the centreline of the tone-arm should all be parallel with the surface of the record. The alignment protractor has been printed to act also as a height gauge in conjunction with the white lines on the side of the tone-arm. Measure the distance from the surface of the record to the upper of the two lines at the front of the tone-arm using the left-hand scale.

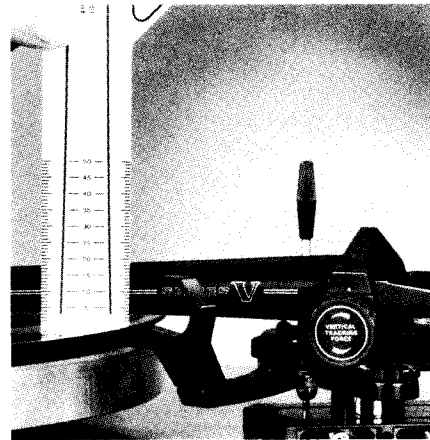

524

Re-position the protractor about 6 mm ($1/4$ ") from the edge of the record. Using the right-hand scale repeat the measurement and compare it with the first one. Adjust the VTA screw until similar readings are obtained indicating that the arm is level with the surface of the record.

Other dispositions can of course be accommodated and if the readings are noted can be quickly implemented for special needs. Do not remove the VTA screw at this point.

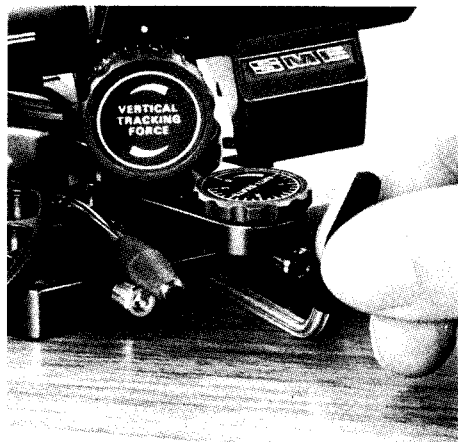

525 Horizontal tracking angle (HTA) adjustment

Insert the HTA key into the socket situated centrally in either of the base slideways. Use a light pressure, rocking it slightly to ensure full engagement of the pinion with the toothed rack in the base. Rotation of the key in either direction will now cause the base to move between the slideways. Do not use force. If the movement is tight, check that the clamp bolts are sufficiently released; also that the cut-out in the pick-up mounting board is affording proper clearance. When all is well rotate the key to traverse the arm into its fully forward position.



526

With the record still on the turntable replace the bush and alignment protractor. Check that the anti-skate control is at zero and the VTF control is set to suit the cartridge in use. The stylus position on the protractor is indicated by a cross. Place it so that the stylus drops into the indent formed at the intersection of the two lines, taking the utmost care not to touch or knock the tone-arm once it is engaged.

Rotate the HTA key to move the tone-arm and the protractor backwards until, when viewed directly from above, their outlines coincide.

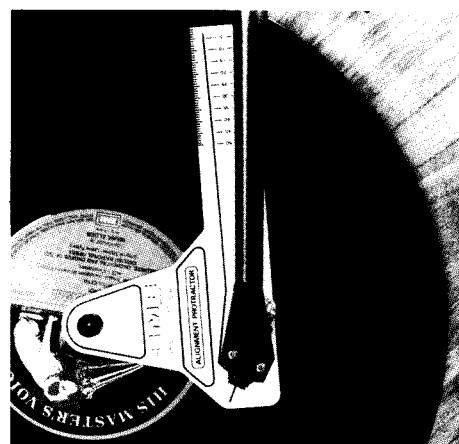

527

Movement has been made too far and opposite rotation of the HTA key is required to correct it.



528 Horizontal tracking angle (HTA) adjustment (continued)

Most cartridges have a stylus – fixing-hole centre distance of 9.5 mm (.375"). Correctly adjusted with these, the outlines of the tone-arm and protractor will coincide when viewed directly above the centre line of the tone-arm. With others, according to the position of the stylus, it will be necessary to view slightly to the left or right of the centre line; the only requirement for correct HTA being that the outlines appear to coincide along their length as shown.

Place the arm in the armrest and remove the alignment protractor, leaving the bush on the record spindle.



529 Positioning the armrest

Place the mounting template under the tone-arm and over the bush. Keeping the tone-arm in the armrest, swing it radially until it coincides with the two profile lines and is approximately square with the template, as shown. This relationship of the armrest with the record spindle is essential for the correct operation of the anti-skate control.

Remove the template and the bush.

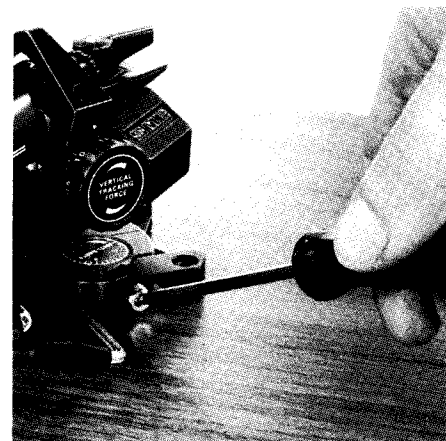

530 Locking the base

Tighten the two clamp bolts evenly and firmly. Excessive tightening is unnecessary and should be avoided. Remove the VTA screw and HTA key.

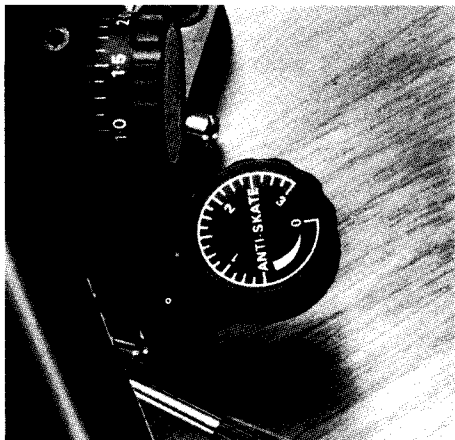

531 Anti-skate control

The dial is calibrated to correspond with the VTF scale and should be rotated until the required position coincides with the index point. Bias requirements are dependent on a number of variables and the recommended setting will be found a good compromise. The situation lends itself to experiment. Listen for any discrepancy in performance between the left and right channels. If the left channel mistracks, reduce the setting, and if the right channel mistracks increase it.

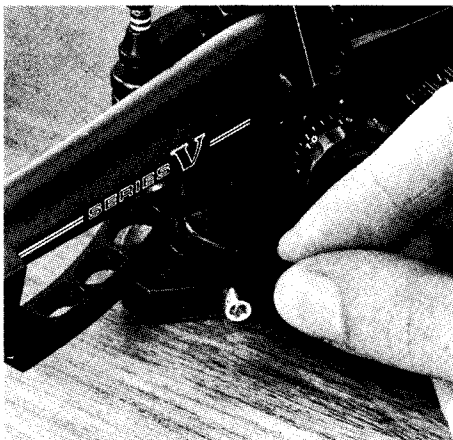

532 Operation

With the control lever in the raised position move the tone-arm out of the armrest.



533

Position the arm so that the stylus is over the selected band of the record.

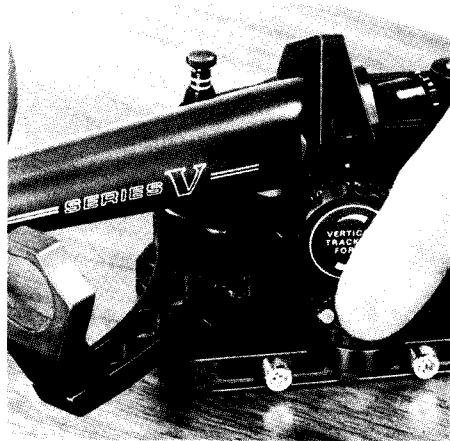

534 Operation (continued)

To lower the stylus onto the record move the control lever forward just over top centre. This will set the lowering control in motion, at which point it will take over the movement of the lever.

For the correct descent time the control must be operated in this way. The speed will be increased considerably if the lever is pushed down rather than moving of its own accord.

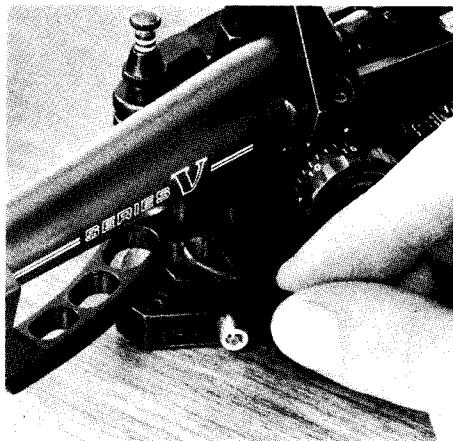

535

To raise the stylus from the record move the control lever back to its original position. When the arm is not in use it should always be returned to the armrest for safety.

This also closes the damper reservoir cover and protects the fluid from foreign matter, Figure 537.

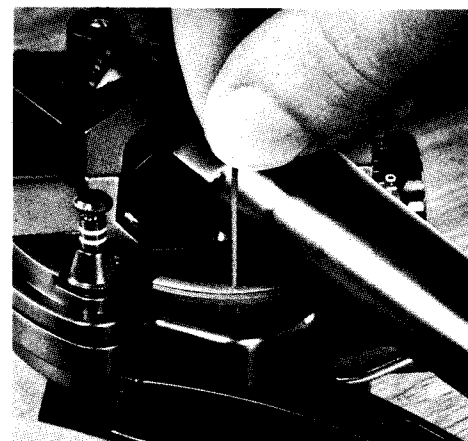

536 Adjusting height of lift

The raising and lowering control is set to suit the majority of cartridges but the height raised above the record can be changed to meet individual needs. The small hole in the centre of the arm lift provides access to the adjustment screw. Insert the long leg of the 0,89 A/F hexagon wrench through this hole to engage the screw. Clockwise rotation will decrease the height of lift; anti-clockwise rotation will increase it. The adjustment is sensitive so the wrench should be turned only a few degrees at a time.

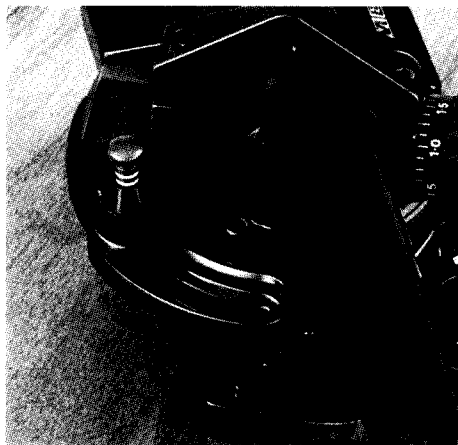

537 Filling the damper reservoir

With the control lever in the raised position, move the tone-arm out of the armrest, swinging it towards the turntable spindle as far as it will go. This will open the reservoir cover.



538

Remove the cap and seal from the syringe and holding it as shown slowly depress the plunger to expel the fluid. Fill from the rear and work forwards, pausing from time to time while the fluid settles.

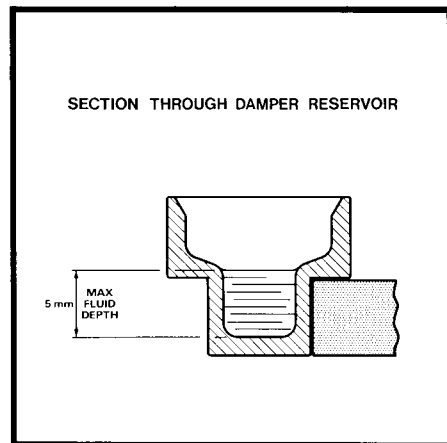

539

Only the lower section of the reservoir has to be filled. The deep rim is to prevent spillage in the event of rapid arm movement. The syringe contains sufficient fluid for two fillings.

Replace the cap, seal with adhesive tape and store safely.

We recommend an annual fluid change. Use only genuine Part No. P908, obtainable from your dealer or direct from us.

WARNING

Silicone fluid can cause discomfort if introduced into the eyes. It is therefore advisable to wash your hands at this point.

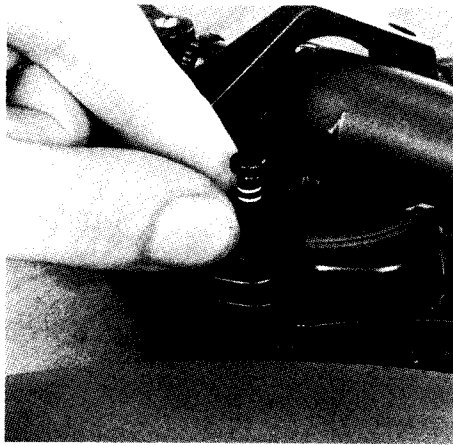

540 Operating the damper

The degree of damping is controlled by a dip-screw and its depth of engagement with the fluid, from which it can also be withdrawn when damping is not required.

To release the dip-screw for setting, the locknut should be rotated anti-clockwise about two turns.



541

Clockwise rotation of the dip-screw increases damping and anti-clockwise rotation reduces it. The white rings on the screw are for reference, allowing setting to be noted and repeated. The system applies damping in the horizontal plane only.

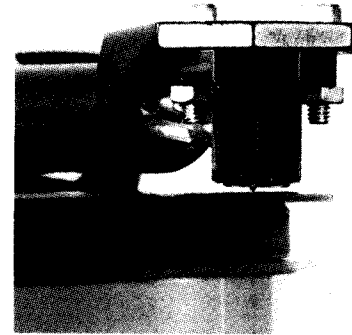

542

View the cartridge head-on whilst it is negotiating the record run-in groove. The stylus should enter the music groove smoothly without lateral oscillations of the arm. Increase damping as required to achieve this. Finally re-tighten the locknut.

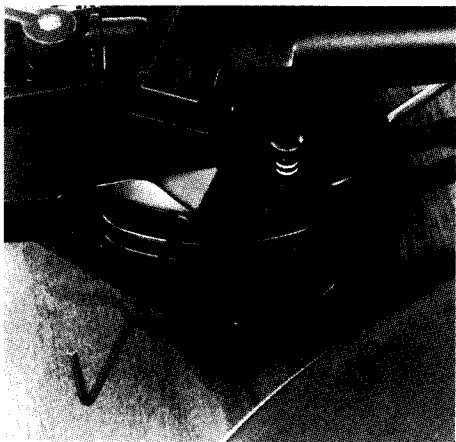

543 Cleaning the damper reservoir

Release the dip-screw locknut, Figure 539. Rotate the dip-screw anti-clockwise until it is clear of the fluid. Remove the two socket cap screws which secure the reservoir cover, using the $\frac{1}{16}$ " A/F hexagon wrench. Place the cover on a paper tissue to be cleaned at a later stage.

WARNING

At this point the horizontal bearing adjustment nut will be visible. Do *not* be tempted to interfere with it, to do so will invalidate the guarantee and almost certainly cause permanent damage to the bearings.

FURTHER WARNING

Do not invert the arm unless the damper reservoir is first emptied and cleaned or removed.

If the damping fluid is spilled it can enter the pillar bearings and in this event their replacement is not covered by the guarantee.

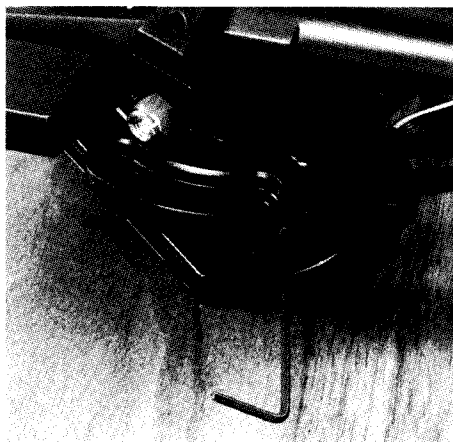

544

With the same wrench remove the two socket cap screws securing the damper reservoir to the control bracket. It can now be lifted clear and inverted on some tissue to drain. The VTA screw works in a brass nut housed in the control bracket and this will be visible when the reservoir is removed. Do not interfere with it. Wipe out any fluid remaining in the reservoir with a tissue and wash it and its cover with a small soft brush in warm water to which a few drops of washing-up liquid have been added. Dry with a clean tissue.

Re-assemble in the reverse order, entering the screws carefully taking care not to cross the threads. Tighten firmly and evenly, only when all the screws have been fitted. Do not over-tighten.

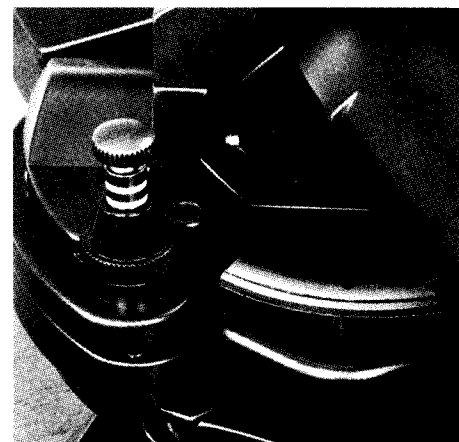

545 Cleaning the arm lift

If the arm drifts outwards during raising and lowering it usually indicates the presence of contaminant on the rubber pad in the arm lift. To restore positive working wipe the pad with a damp cloth and repeat with a paper tissue until dry. Clean the underside of the tone-arm in the same manner where it contacts the rubber pad.

Appendix

We hope these instructions have made the installation of your Series V precision pick-up arm straightforward. Care for it as you would a camera. Do not attempt to take it to pieces. Do not apply oil or other lubricant to any part of it.

If you have a problem concerning operation or service, contact us at the address overleaf in the first instance, quoting the unit's serial number. Do not send the arm to us unless requested to do so. We provide a quick, efficient service through our agents or direct from the factory to any part of the world.

SERIES V
MAGNESIUM TONE-ARM

MANUFACTURED BY · SME LIMITED · STEYNING · SUSSEX · BN4 3GY · ENGLAND

☎ (0903) 814321 · ☒ (0903) 814269