

# INSTRUCTIONS MODEL 3009 SERIES II IMPROVED



**SME**

SME Model 3009 Series II Improved precision pick-up arms combine la design features with the same high quality engineering and finish that made their predecessors famous for more than a decade.

Each arm is meticulously built and tested and will meet its specification reliably through many years of service. Skilful design and choice of materials combine high mechanical strength with low inertia and friction ensuring full suitability for professional as well as domestic application.

Technically correct and aesthetically satisfying the SME has been called "The best pick-up arm in the world" and we believe you will find this to be true.

## **CONTENTS**

### **Page**

<b>4</b>	<b>Setting out</b>
<b>5</b>	<b>Fitting the Arm</b>
<b>6</b>	<b>Fitting the Cartridge</b>
<b>7</b>	<b>Model 3009/S2 Improved (detachable shell)</b>
<b>8</b>	<b>Audio Lead</b>
<b>9</b>	<b>Pillar Adjustment</b>
<b>10</b>	<b>Shell Adjustment</b>
<b>11</b>	<b>Tracking Adjustment</b>
<b>12</b>	<b>Balance Adjustment</b>
<b>13</b>	<b>Bias Adjustment</b>
<b>14</b>	<b>Operation</b>

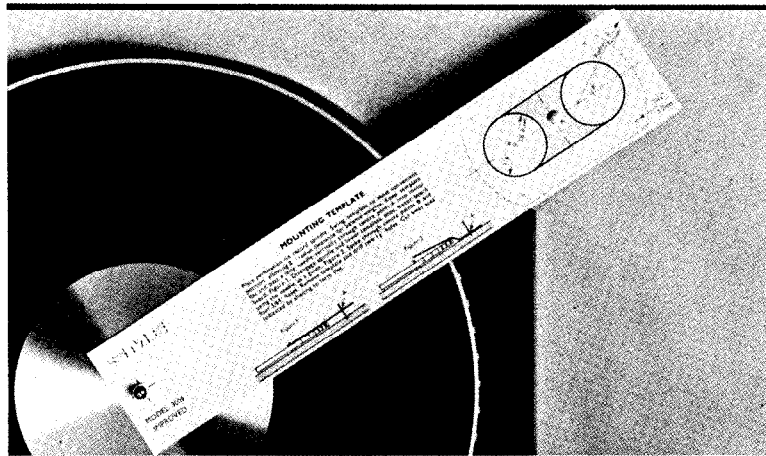

101

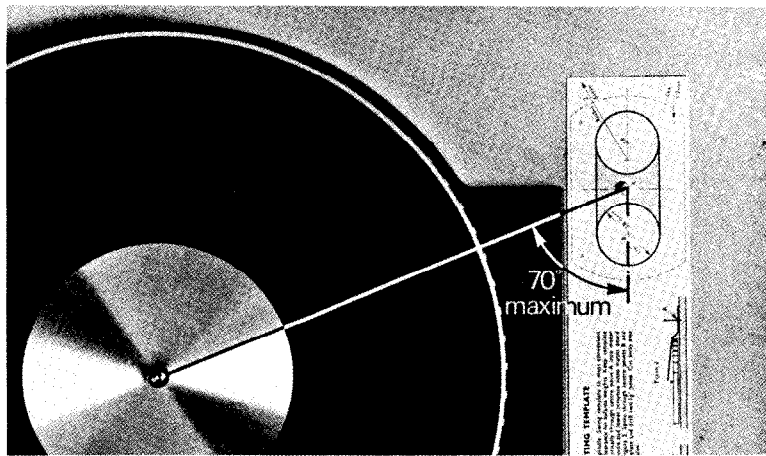

102

**Setting out**

101 Establish the position for the bedplate with the mounting template.

102 Where space is restricted the template may be rotated up to 70° off the radial position.

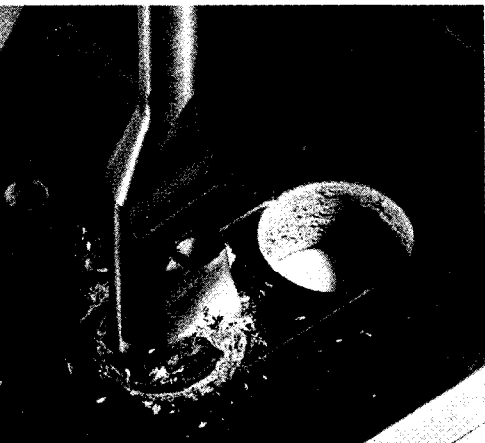

**103**

103 Drill and form the cut-out in accordance with the template. Ensure that it is large enough to clear the screening can completely. Drill the four  $\frac{3}{64}$ " (1.2 mm.) pilot holes for the wood-screws.

104 Screw down the bedplate with the four wood-screws.

105 Adjust the screws as shown.

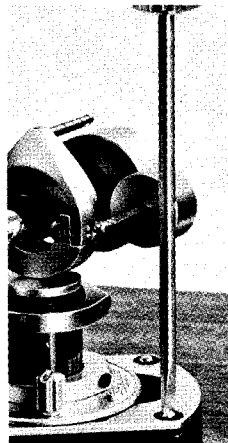

**104**

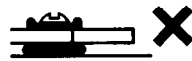

**105**

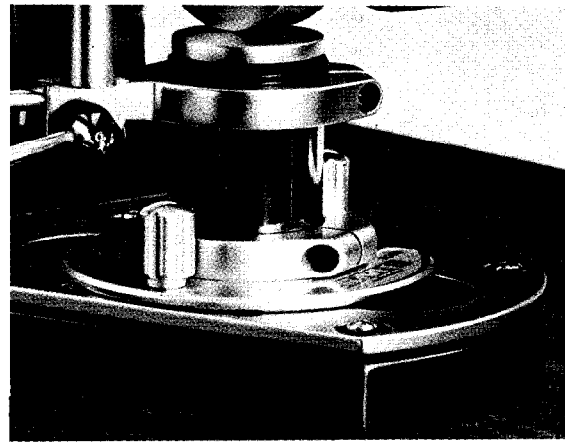

**106**

106 When the surface of the turntable is more than 1%" (41 mm.) above that on which the bedplate is mounted a spacer SME Accessory P.I is required.

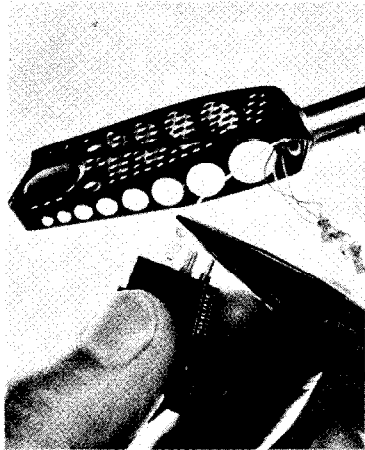

107

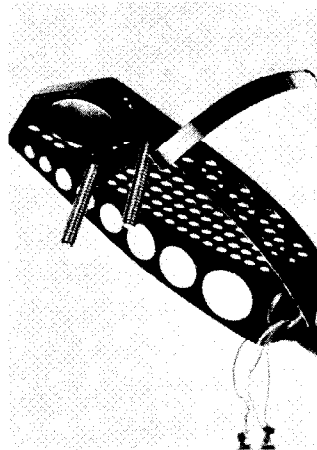

108



109

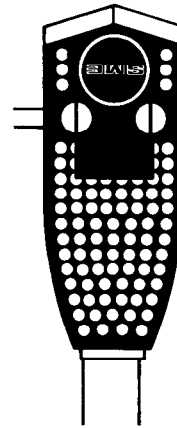

110

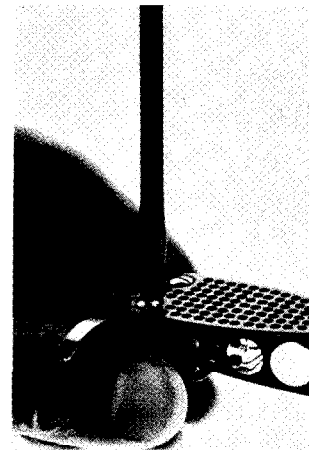

111

#### Fitting the cartridge

**107** Fit the pin jacks to the cartridge terminals: White to left channel: Red to right channel: Blue to left ground: Green to right ground. Tails must never be soldered direct to the cartridge terminals.

**108** Select screws of appropriate length. The top of the cartridge should lie snugly against the shell or as close to it as possible. The use of the finger lift is optional. Use spacers only if cartridge contours make it essential.

**109** Fit the nuts.

**110** Check that the cartridge lies symmetrically in the shell. This is important.

**111** Tighten the screws taking care to preserve (110)

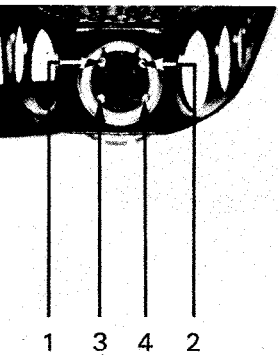

112

**Model 3009/S2 Improved  
(detachable shell)**

112 Fit the tails to the shell terminals:  
White (1) to left channel: Red (2) to  
right channel: Blue (3) to left ground:  
Green (4) to right ground. Fit the  
cartridge as detailed on Page 6.

113 Insert the shell in the arm socket.

114 Press in to contact the thread.

115 Maintaining pressure, rotate the  
socket nut to draw the shell firmly  
home. Do not over-tighten.

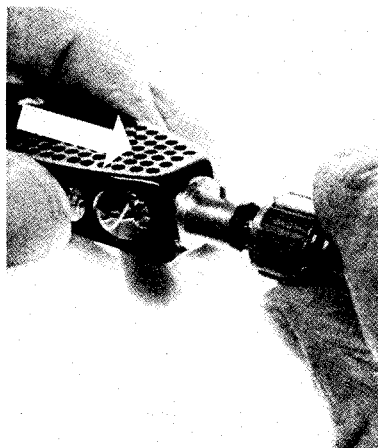

113

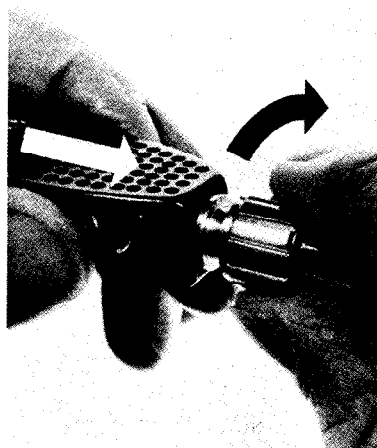

114

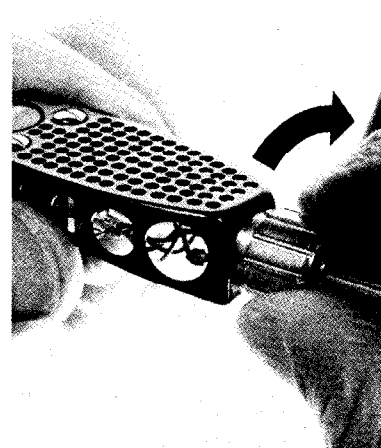

115

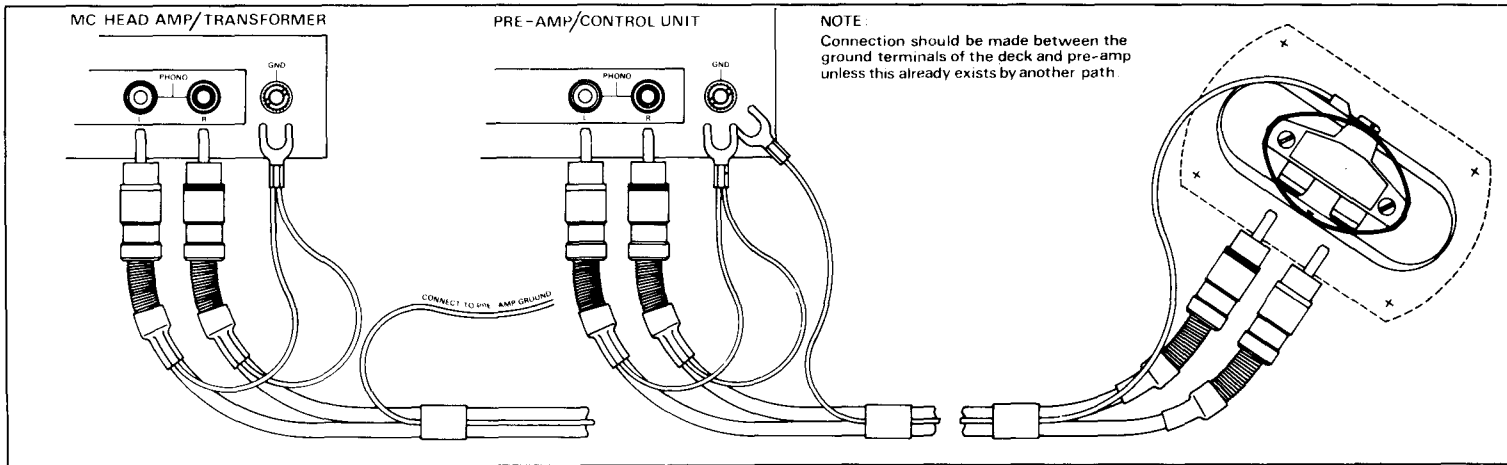

116

### LCOFC Audio Lead

**116** The illustration shows use with and without a mc head amp/transformer and phono plug connections should be made accordingly.

Connect the ground lead serving the arm to the pre-amp ground, and those from the rear of the phono plugs to the ground terminal on the piece of equipment to which these plugs are connected.

If the turntable has a ground terminal, it too should be connected to the pre-amp ground, provided it is not already grounded by another path.

The system has been designed for a high S/N ratio and if this is not achieved multiple ground paths or the over proximity of mains equipment will be likely causes. Some cartridges have an external foil tag connecting the right channel ground terminal to the cartridge body. For use in a metal shell it will be necessary to remove this with a small pair of tweezers or the point of a blade, lifting the tag off over the terminal pin. If this is not done a ground loop may be formed, causing hum on the right channel.



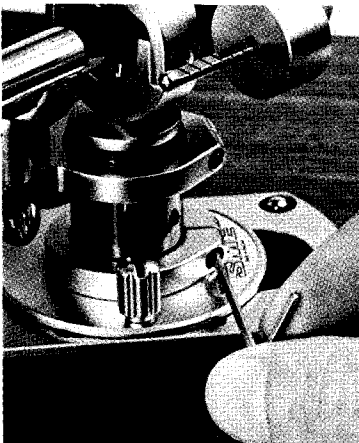

119

119 Release the cap screw in the base to unlock the pillar.

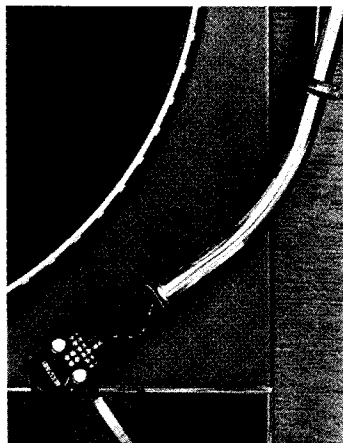

120

120 Rotate the pillar to position the arm-rest in a convenient position relative to the turntable.

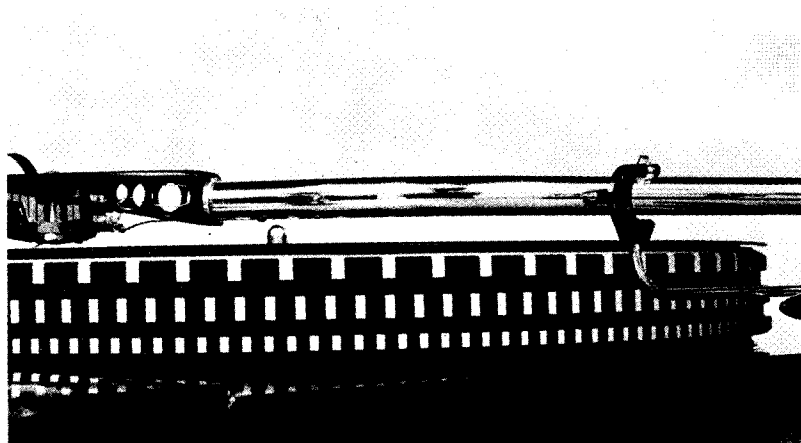

121

121 Set the pillar height so that the arm is parallel with the record surface when playing. Check that there is clearance between the tone-arm and the rubber surface of the lowering and raising control when the lever is in the down position. If one does not clear the other, the pillar is set too high. Relock the cap screw.

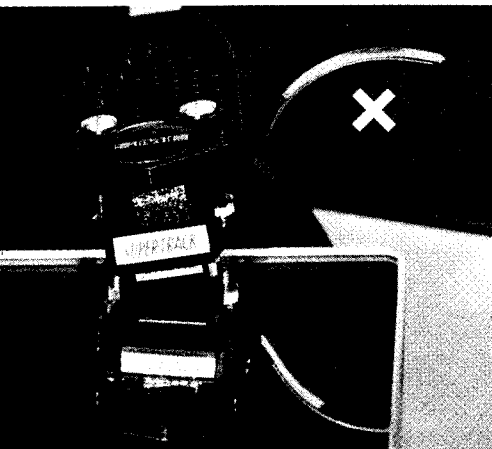

122



123

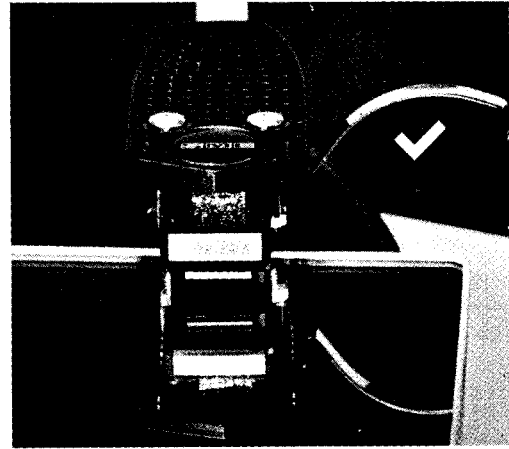

124

### Shell adjustment

**122** Place a small flat mirror on the turntable and rest the stylus on it.

**123** If necessary hold the shell firmly close to the tone-arm and twist in the required direction with one hand whilst holding the arm firmly with the other. *The stylus must be clear of the mirror whilst this is done.* Movement of the socket in the end of the tone-arm is limited by a detent screw.

**124** Recheck with the mirror.

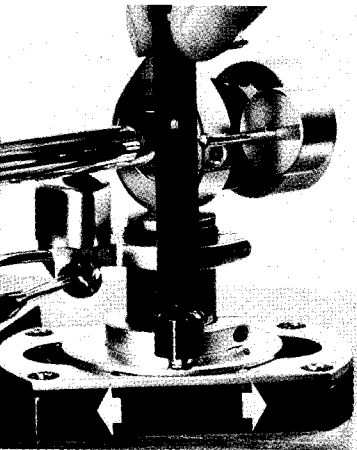

125

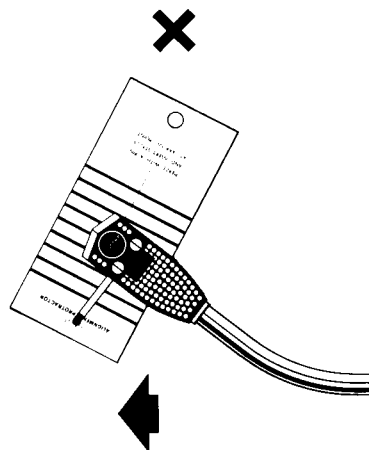

126

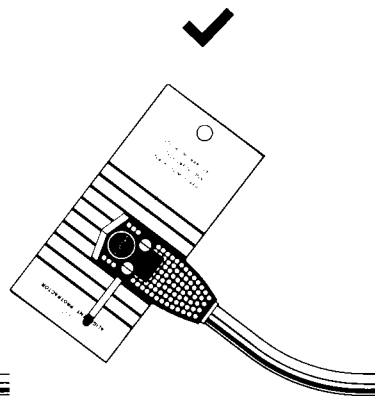

127

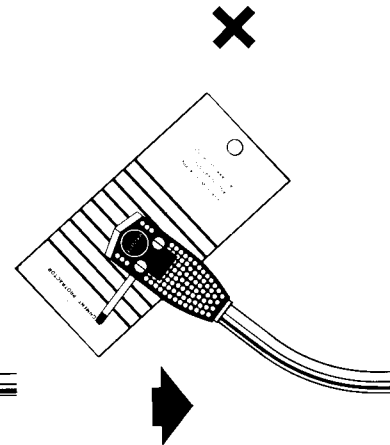

128

### Tracking adjustment

125 Release the base clamp nuts with the plastic box spanner.

126 Place a record on the turntable

127 with the alignment protractor on

128 top of it. The large hole engages

the record spindle with the stylus

in the small one. Move the base on the

bedplate until the cartridge and shell

appear symmetrical with the protractor.

Relock the base clamp nuts.

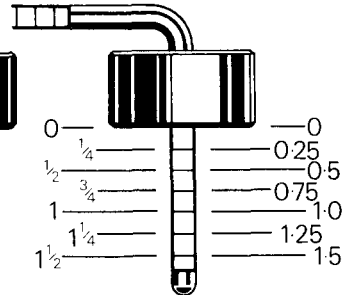
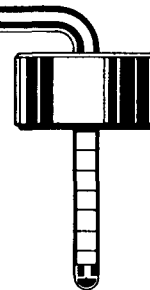
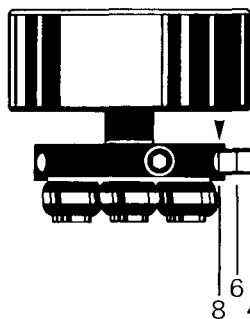
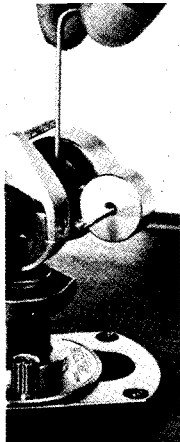
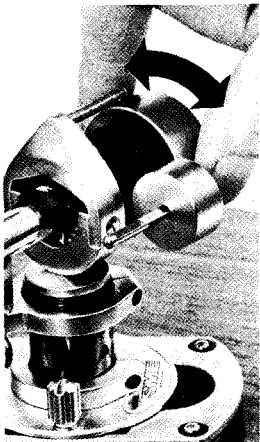
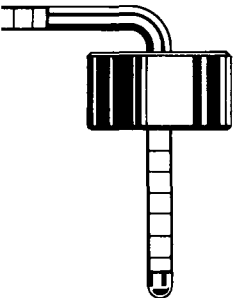

129

130

131

132

133

### Balance adjustment

**129** Position the rider weight so that its front coincides with the first division of the wayrod.

**130** Place the arm in a state of equilibrium by rotating the balance weight in the required direction.

**131** Release the set screw in the wayrod housing.

**132** Divisions correspond to cartridge weights in grams. Adjust as required for your cartridge. The setting shown is for 8 grams.  
Relock the set screw.

**133** Apply tracking force by advancing the rider weight along the wayrod. Each division travelled applies  $\frac{1}{4}$  (.25) gram tracking force at the stylus.

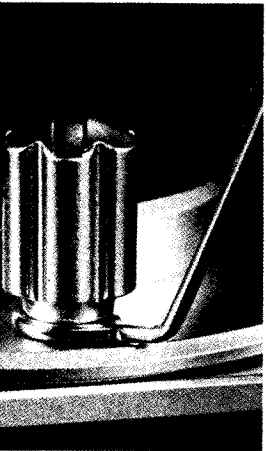

134

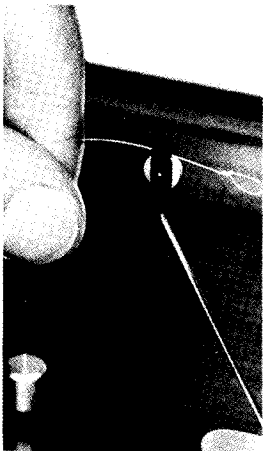

135

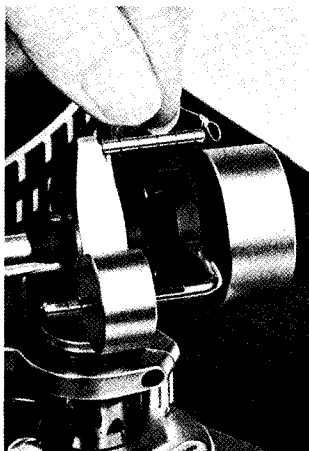

136

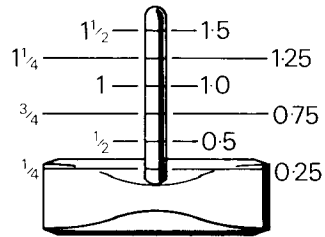

137

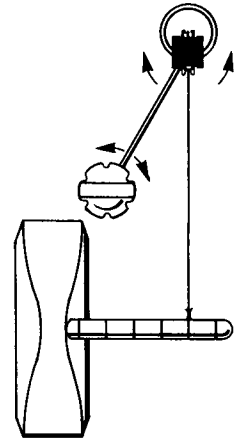

138

### Bias adjustment

**134** Fit the eye of the bias guide under the base clamp nut nearest to the turntable.

**135** Thread the nylon through the guide pulley housing and pass the loop over the bias lever.

**137** Place the nylon loop in the groove corresponding to the tracking force being used.

**138** Position the bias guide so that the thread is at approximately 90° to the bias lever when the stylus is over the outer groove of a 12" record. Rotate the guide pulley housing to align it with the thread which must lie in the groove of the pulley.

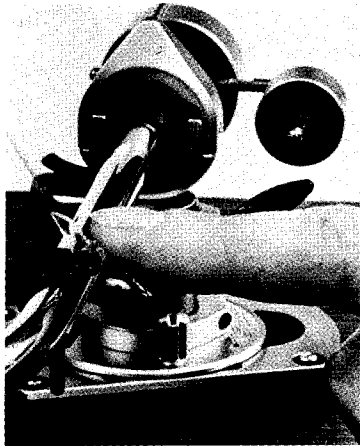

139



140

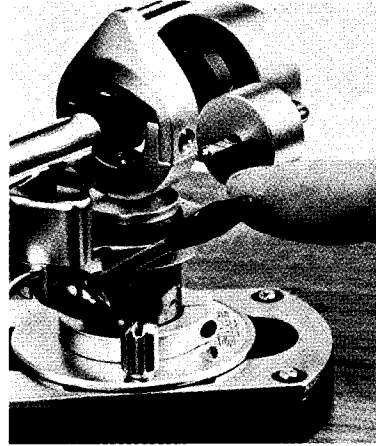

141



142

### Operation

**139** With the control lever raised release the tone-arm from its rest.

**140** Place the stylus over selected band on the record.

**141** Move the control lever forward

**142** allowing it to fall freely.

After playing, raise the control lever to lift the stylus from the record. Return the arm to its rest.

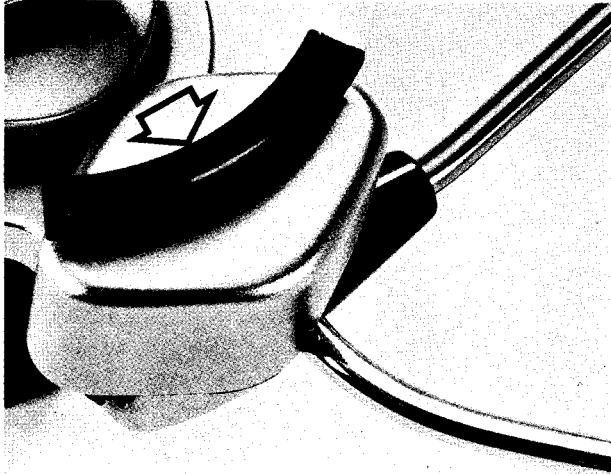

We hope these instructions have made installation of your SME precision pick-up arm simple and straightforward. Care for it as you would a camera. Do not attempt to take it to pieces. Do not apply oil or other lubricants to any part of it.

If the arm drifts outwards during lowering and raising it usually indicates the presence of contaminant on the rubber insert in the arm lift. To restore positive working proceed as follows:-

- a) Wipe the insert with a damp cloth.
- b) Repeat with a paper tissue until it is quite dry.
- c) Clean the underside of the tone-arm where it contacts the rubber insert in the same way.

If you have a problem concerning the operation or repair of your pick-up arm, write to the address overleaf. We provide quick and efficient service direct from the factory to any part of the world. In the first instance please quote the model, type and serial number. Do not send the arm to us unless requested to do so.

**SME**

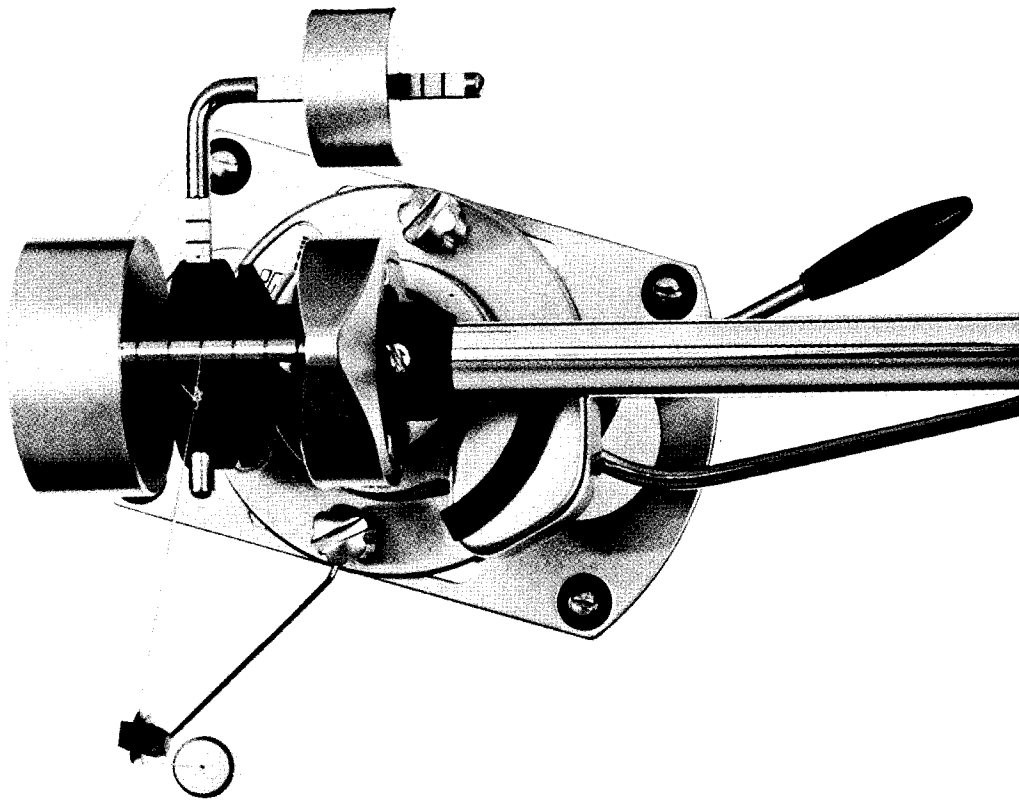

PRECISION GRAMOPHONE EQUIPMENT

Manufactured in England by **SME LIMITED · STEYNING · SUSSEX · BN44 3GY** ☎ 01903 814321 ☒ 01903 814269